



PRODUCT MANUAL



arozzi.com

Thank you for buying our product . To ensure safety , please read this manual carefully before installation and follow the instructions herein. Store this manual in a secure place for future reference.

NOTES

1. Please avoid any fire, direct sunlight, wet environment and sharp objects.
2. Please do not put the chair on a high or unstable place, so you do not fall down.
3. Please put the chair on a flat surface.
4. Please do not use the chair as a ladder.
5. Please pay attention to the bolts after long term usage, they might loosen.
6. Please avoid tilting the chair excessively, so you do not fall down.

CATALOGUE

CHAIR PARTS DETAILS	01-02
INSTALLATION FIG	03
CHAIR REFERENCE FIG	04
INSTALLATION INSTRUCTION	05-10
FUNCTIONS INTRODUCTION	11
ADJUSTMENT OF CHAIR BACK	12
ADJUSTMENT OF MECHANISM	13
ADJUSTMENT OF MECHANISM TILT FUNCTION	14
ADJUSTMENT OF CHAIR HEIGHT	15
ADJUSTMENT OF ARMREST	16

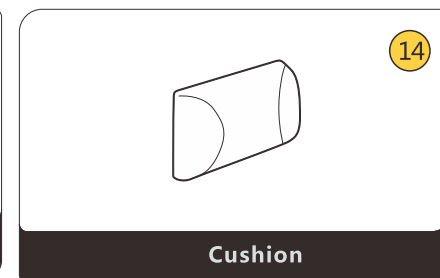
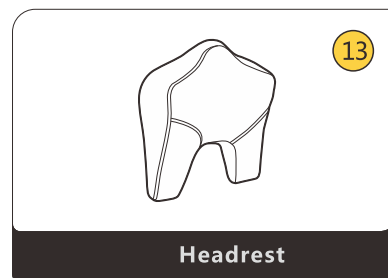
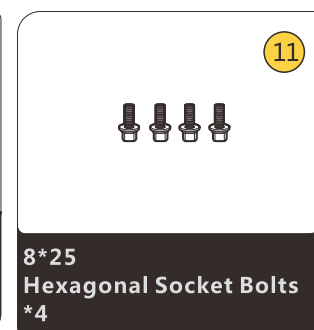
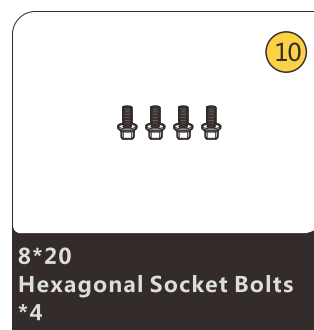
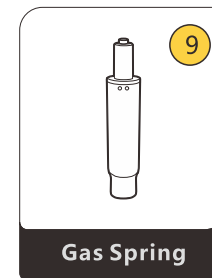
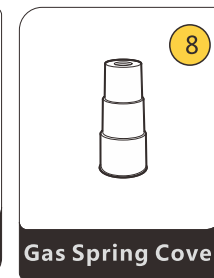
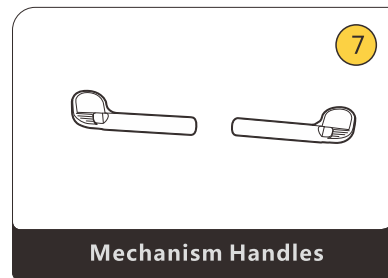
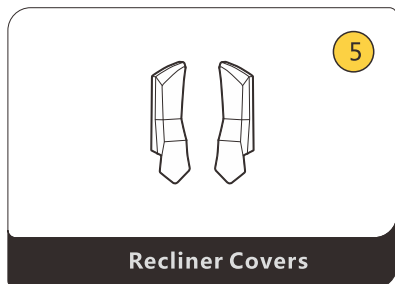
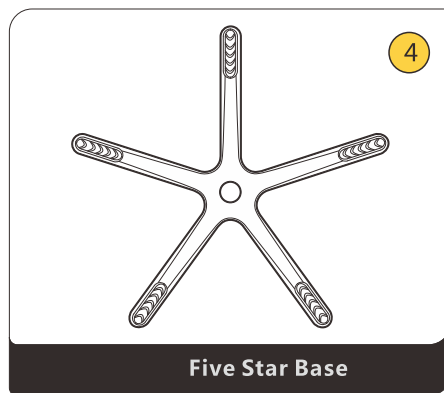
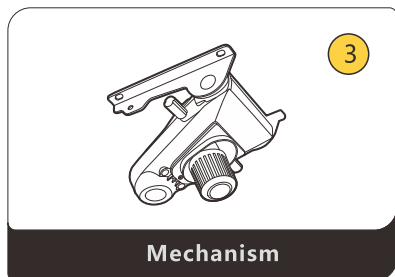
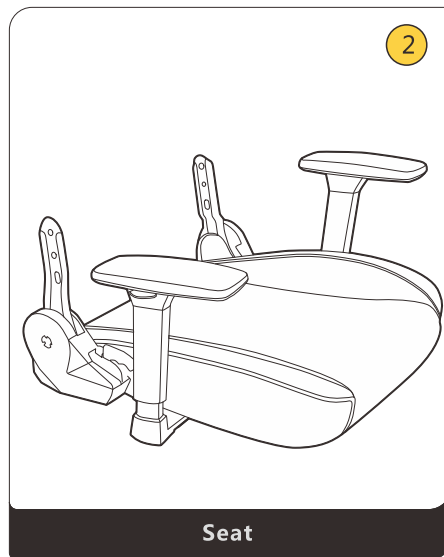
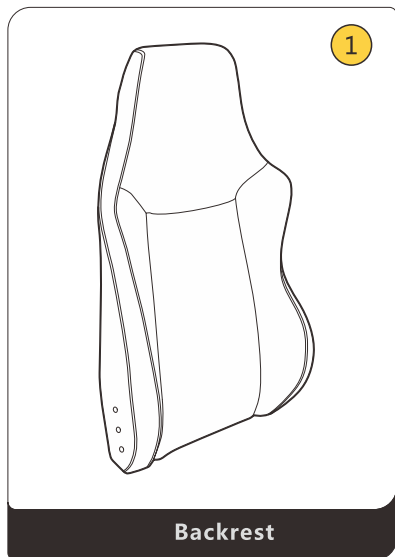

! Please confirm all chair parts after opening the box, then install the chair according to the manual.

● INSTALLATION FIG

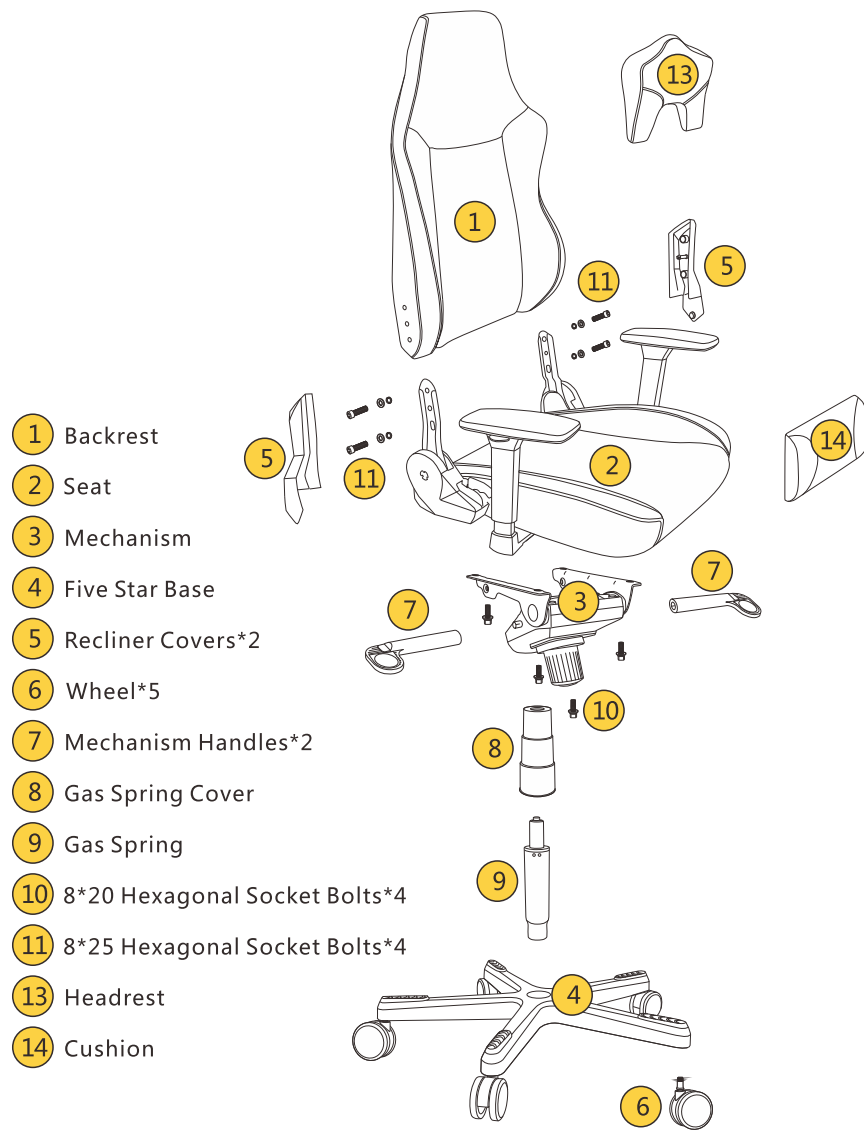

CHAIR REFERENCE FIG ●



● INSTALLATION INSTRUCTION

Step 1

Put the Backrest and Seat together

Put the backrest and seat together as the picture 1. Please pay attention to the red marked spot (left and right sides) as you need to align them with the screw holes.

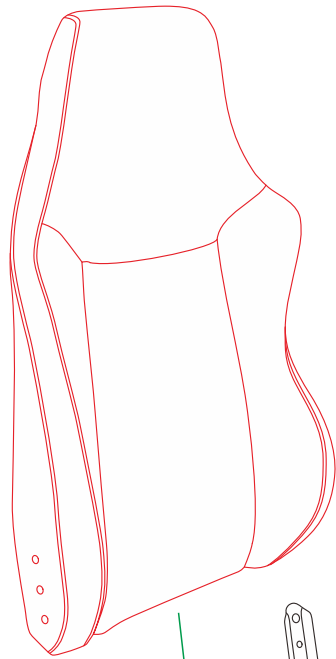

Step 1 Completed

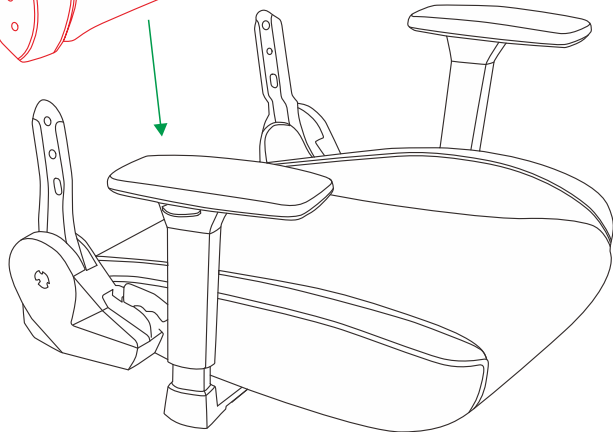

INSTALLATION INSTRUCTION ●

Step 2

Lock the Backrest and Seat

Lock the 4 bolts on the left and right side as the reference picture.

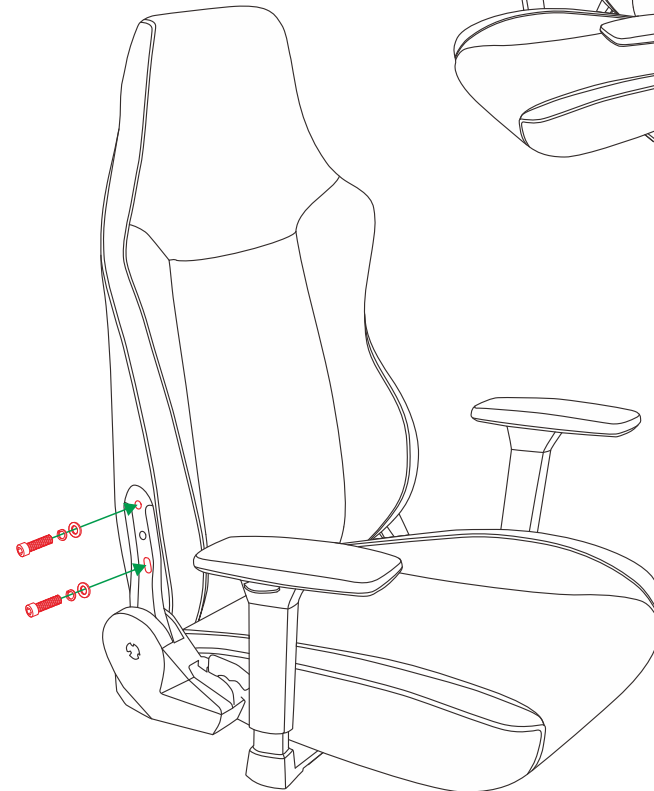
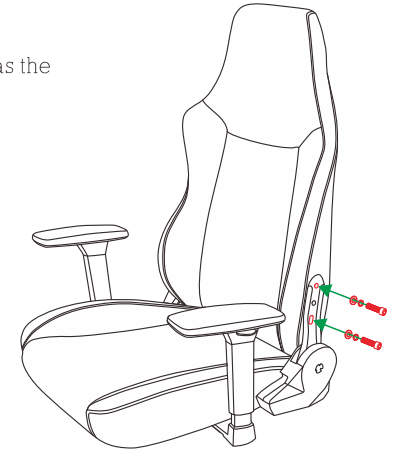

Step 3

Install the recliner covers

Attach the lower snap button first, then the upper snap button. You need to apply some pressure in order to make sure it is installed properly.

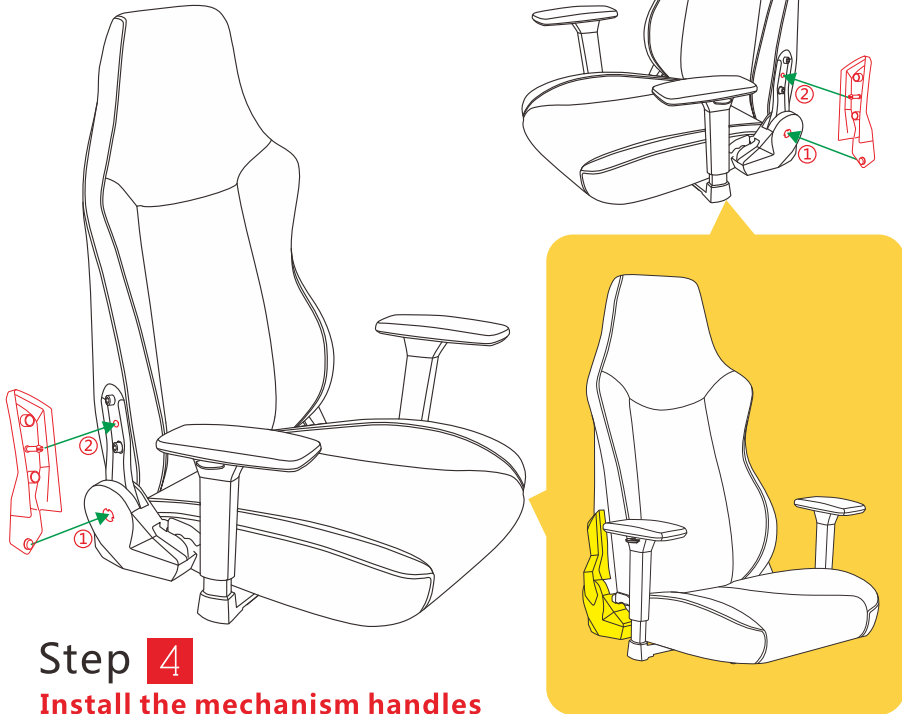

Step 3 Completed

Step 4

Install the mechanism handles

Install the left and right handles to the mechanism according as the reference picture below, you will need to tap them gently in order to make sure they are installed properly.

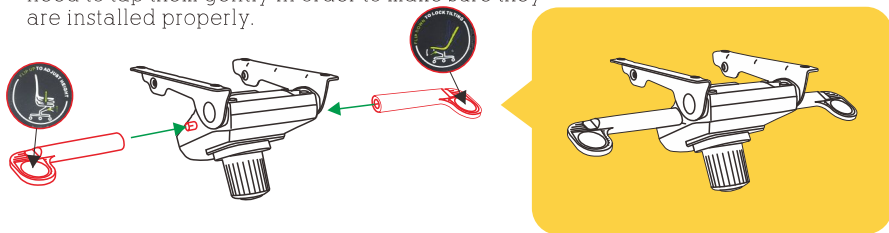

Step 4 Completed

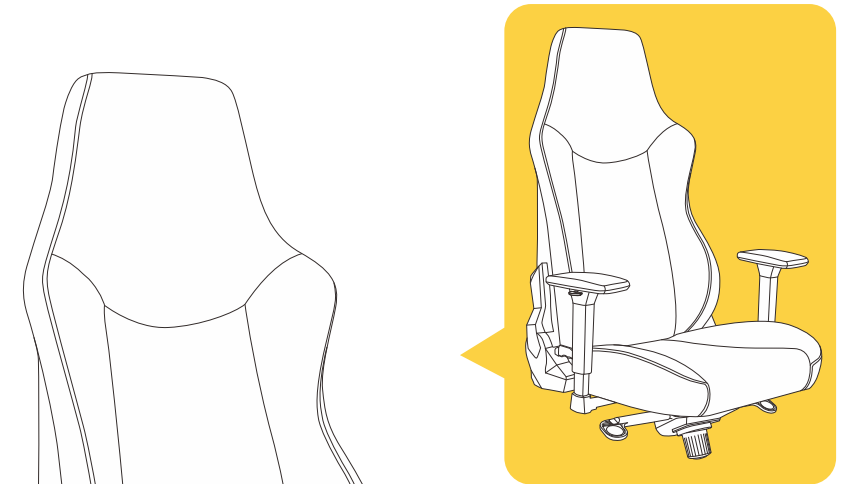

Step 5 Completed

Step 5

Install the mechanism

Use the bolts to lock the mechanism and seat together, and make sure the bolts are screwed in tight.

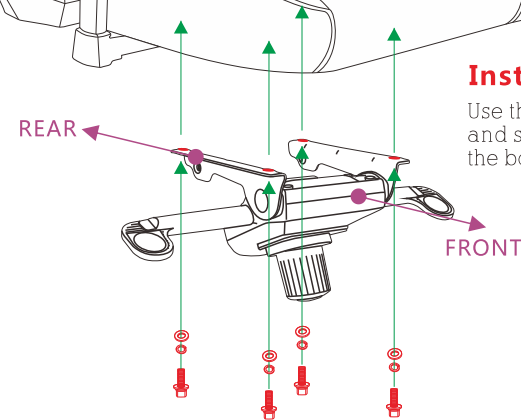

● INSTALLATION INSTRUCTION

Step 6
Install the wheel

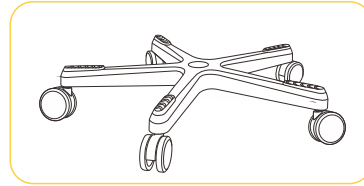
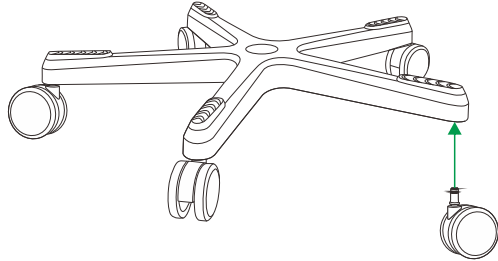

Step 6 Completed

Step 7
Install the gas spring

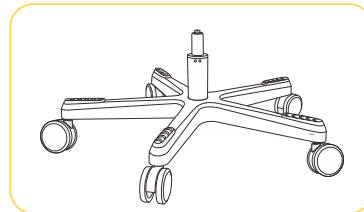
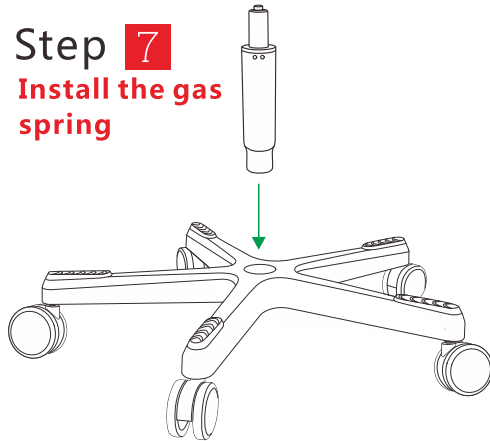

Step 7 Completed

Step 8
Put on the gas spring cover

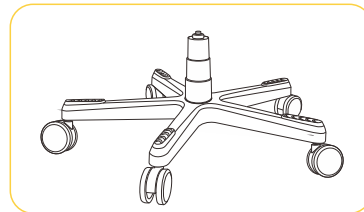
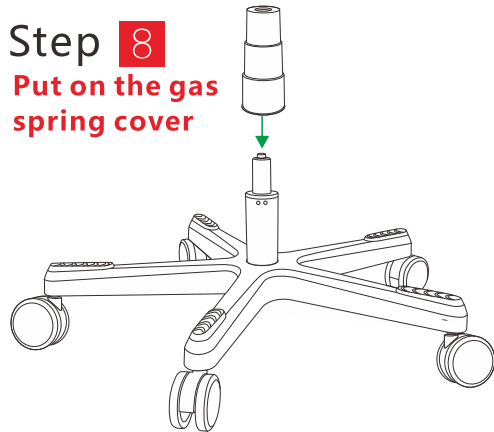

Step 8 Completed

INSTALLATION INSTRUCTION ●

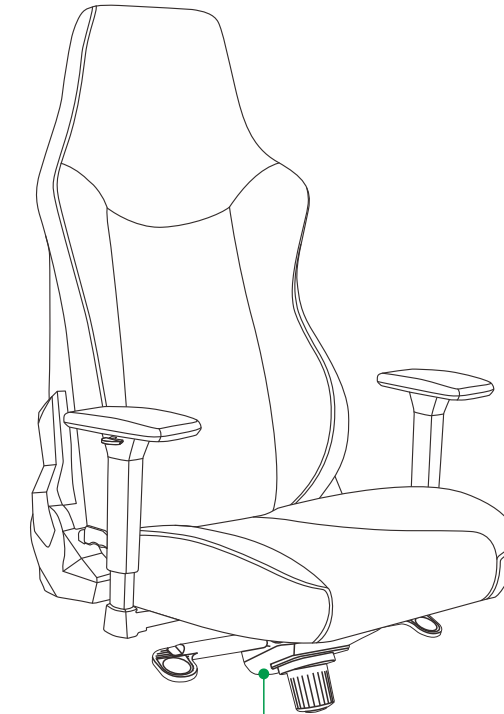

Step 9 Completed

Step 9
Put the chair body on the gas spring

Aim at the top of gas spring and the hole of mechanism, then put the chair body down.

● FUNCTIONS INTRODUCTION

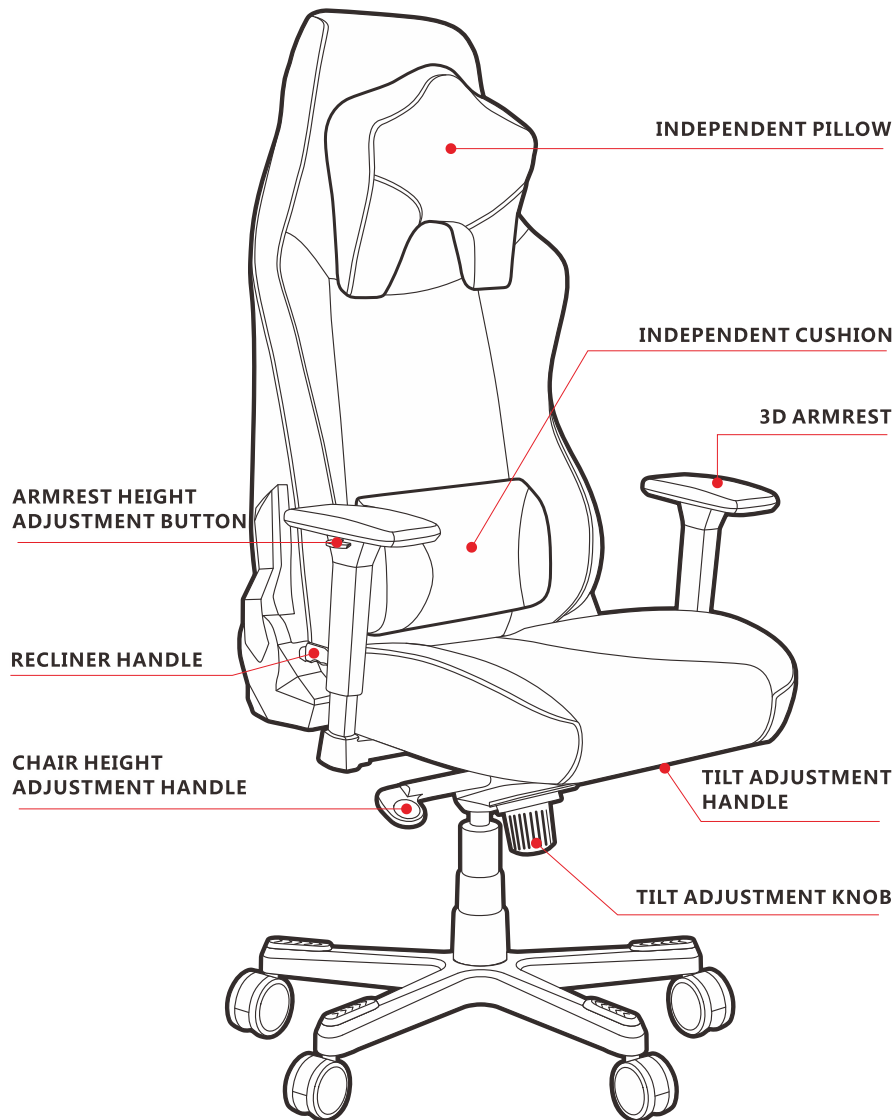

ADJUSTMENT OF BACKREST ●

RELAXING ANGLE

Adjust the chair angle by pulling the yellow marked handle up and down, adjust it to a half-lying position to get a bit more relaxed posture.

WORKING ANGLE

This is the optimal posture for working, use the yellow marked handle to adjust the back to a upright position. Use the mechanism handle to lock the chair, preventing it from rocking backwards.

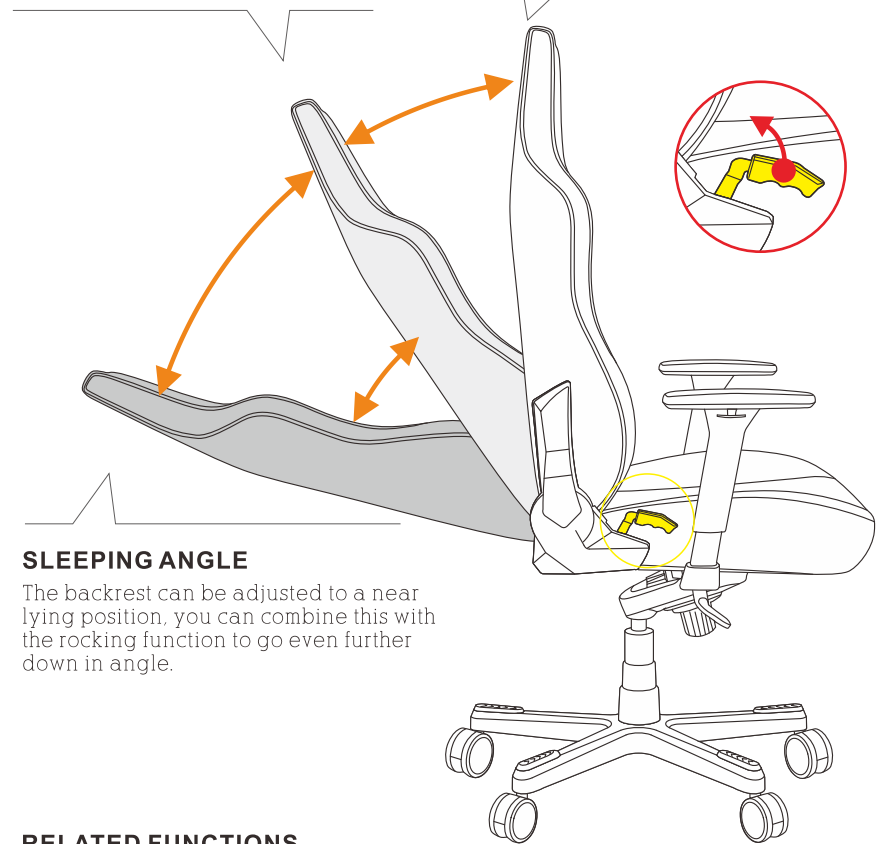

RELATED FUNCTIONS



● ADJUSTMENT OF MECHANISM

ADJUSTMENT OF MECHANISM

Use the red marked handle to enable or disable the chair rocking function.

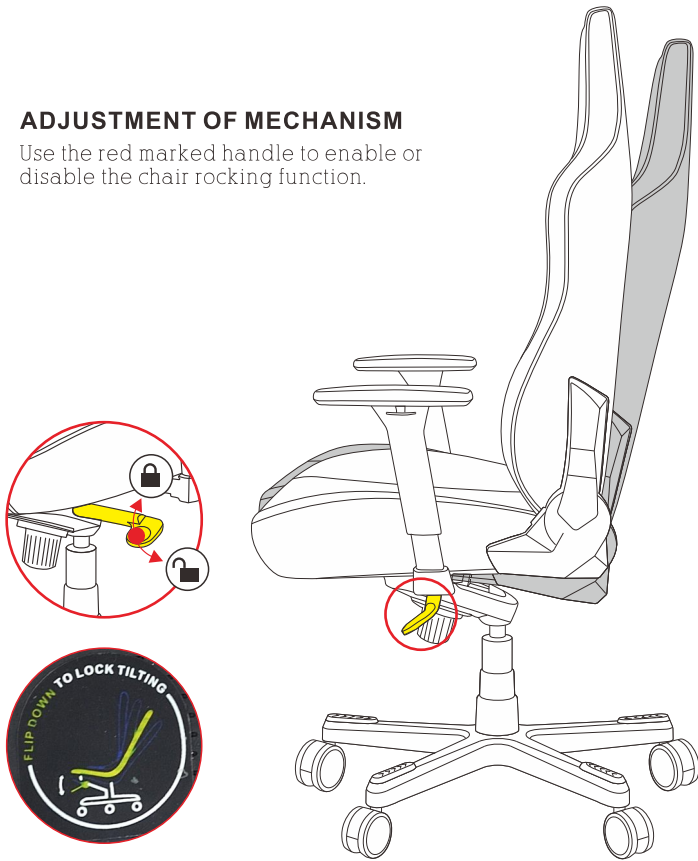

Related functions:

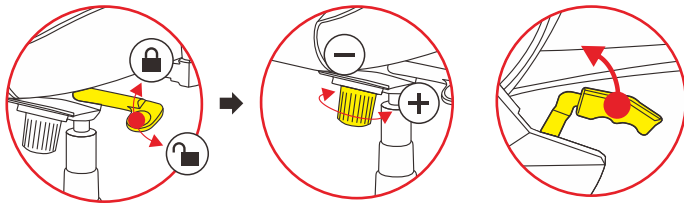

Adjust the resistance to your preference.

Use this to adjust the backrest angle.

● ADJUSTMENT OF MECHANISM TILT FUNCTION

ADJUSTMENT OF MECHANISM TILT FUNCTION

Rotate the red marked knob to adjust the resistance of the rocking function

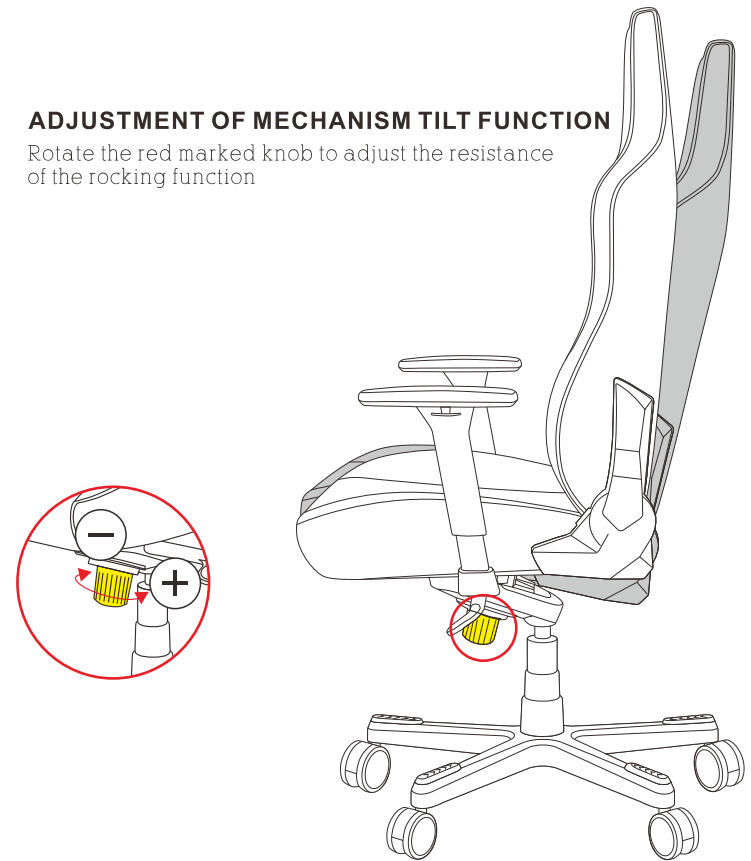

Related functions:

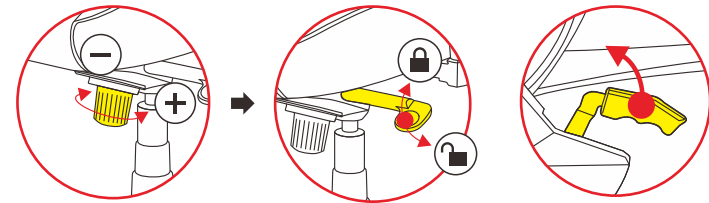

Lock and unlock

Use this to adjust the backrest angle.

● ADJUSTMENT OF CHAIR HEIGHT

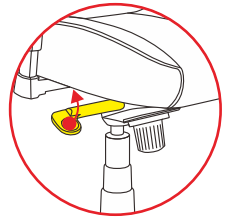

ADJUSTMENT OF CHAIR HEIGHT

Pull up the mechanism handle to adjust the chair height. (When you want to raise the height you should not sit in the chair. And when you lower the height you should sit in the chair.)

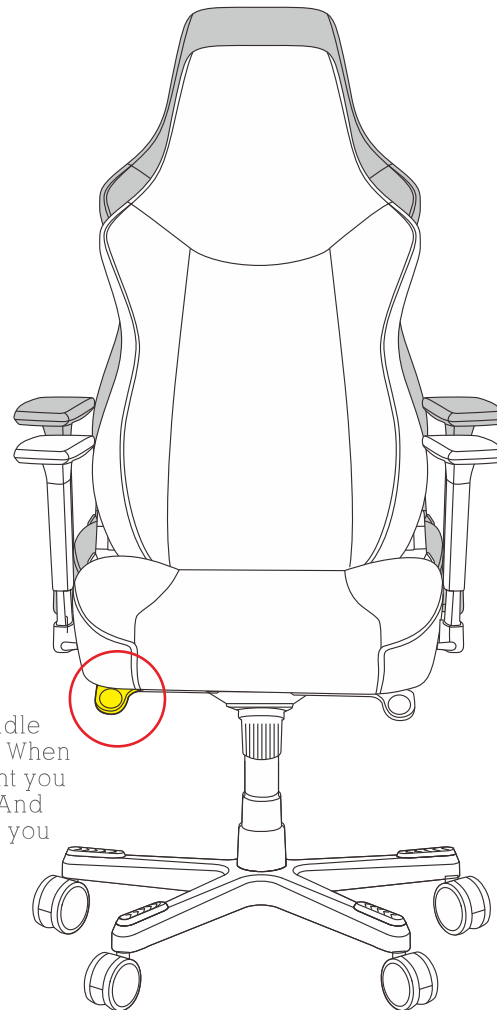

ADJUSTMENT OF ARMREST ●

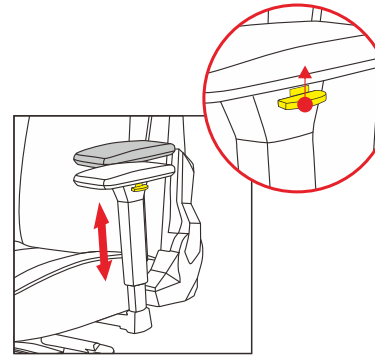

ADJUSTMENT OF ARMREST HEIGHT

Pull the yellow marked button up to adjust the height of the armrest.

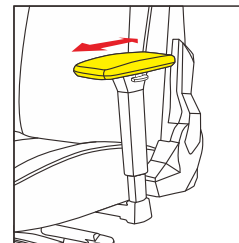

ADJUSTMENT OF ARMREST FORWARD AND BACKWARD

Push the armrest surface back and forth to adjust.

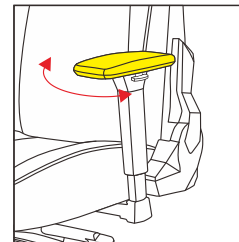

ADJUSTMENT OF ARMREST ANGLE

You can rotate the armrest angle left to right.

