

# B390

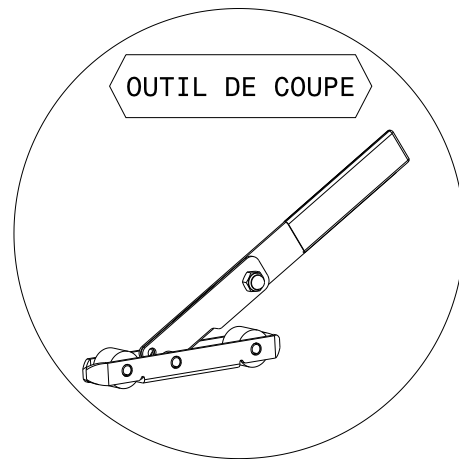

## Composants du B390

Outils nécessaires (non fournis) au montage

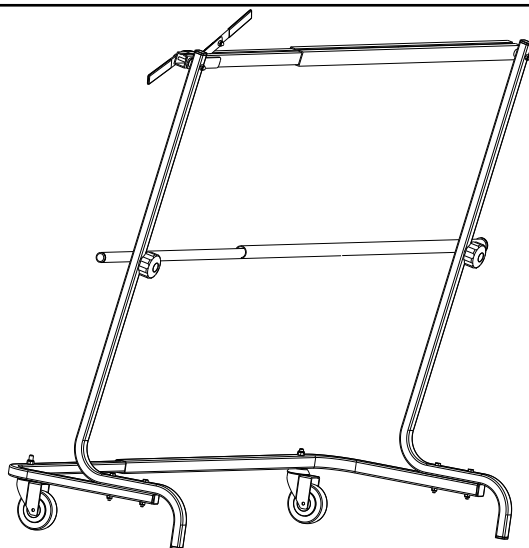
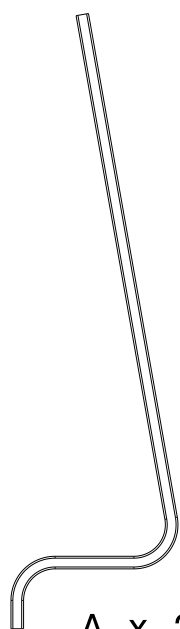
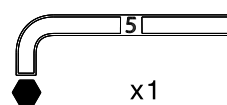
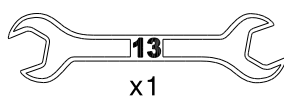
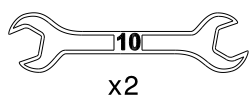

A x 2

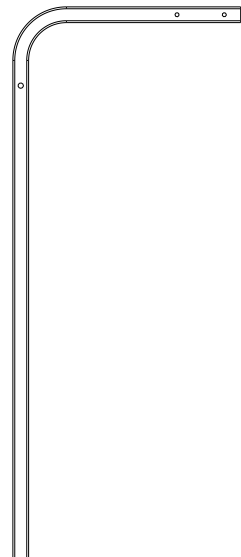

B x 1

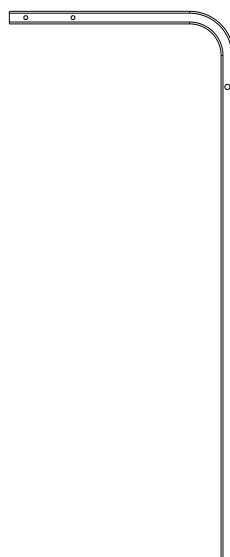

C x 1



D x 1



E x 1



F x 1



G x 1



H x 2



I x 1



J x 5



K x 2



L x 2



M x 2



N x 1



O x 1



P x 1

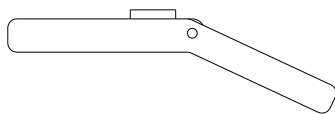

Q x 1



R x 2



S x 6



T x 2



U x 2  
M6 x 50



W x 2  
M6 x 55



V x 2  
M6 x 65

0 10 20 30 40 50 60 70 80 90 100 110

Echelle

mm



